

# TOLSEN X20

## 97132

## LI-ION CORDLESS BLOWER

INSTRUCTION MANUAL

20V LITHIUM-ION

**BL** BRUSHLESS  
MOTOR

INDUSTRIAL

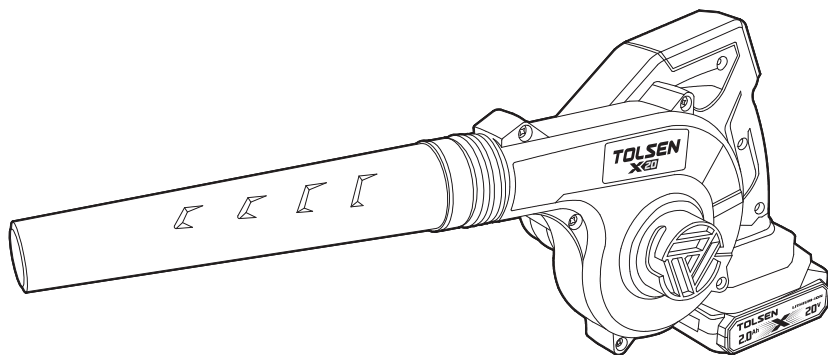

SAVE THIS MANUAL !

You will need this manual for safety instructions, operating procedures and warranty.

Put it and the original sales receipt in a safe dry place for future reference.

## IMPORTANT SAFETY INFORMATION

### General Power Tool Safety Warnings

---

**WARNING** Read all safety warnings and all instructions. Failure to follow the warnings and instructions may result in electric shock, fire and/or serious injury.

**WARNING:** This appliance is not intended for use by persons (including children) with reduced, physical or mental capabilities or lack of experience or knowledge unless they have been given supervision or instruction concerning use of the appliance by a person responsible for their safety.

Children must be supervised to ensure that they do not play with the appliance.

Save all warnings and instructions for future reference

The term "power tool" in the warnings refers to your mains-operated (corded) power tool or battery-operated (cordless) power tool.

### Work Area Safety

---

1. Keep work area clean and well lit. Cluttered or dark areas invite accidents.
2. Do not operate power tools in explosive atmospheres, such as in the presence of flammable liquids, gases or dust. Power tools create sparks which may ignite the dust or fumes.
3. Keep children and bystanders away while operating a power tool. Distractions can cause you to lose control.

### Electrical Safety

---

1. Power tool plugs must match the outlet. Never modify the plug in any way. Do not use any adapter plugs with earthed (grounded) power tools. Unmodified plugs and matching outlets will reduce risk of electric shock.
2. Avoid body contact with earthed or grounded surfaces, such as pipes, radiators, ranges and refrigerators. There is an increased risk of electric shock if your body is earthed or grounded.
3. Do not expose power tools to rain or wet conditions. Water entering a power tool will increase the risk of electric shock.
4. Do not abuse the cord. Never use the cord for carrying, pulling or unplugging the power tool. Keep cord away from heat, oil, sharp edges or moving parts. Damaged or entangled cords increase the risk of electric shock.
5. When operating a power tool outdoors, use an extension cord suitable for outdoor use. Use of a cord suitable for outdoor use reduces the risk of electric shock.
6. If operating a power tool in a damp location is unavoidable, use a residual current device (RCD) or ground fault circuit interrupter (GFCI) protected supply. Use of an RCD or GFCI reduces the risk of electric shock.
7. Power tools can produce electromagnetic fields [EMF] that are not harmful to the user. However, users of pacemakers and other similar medical devices should contact the maker of their device and/or doctor for advice before operating this power tool.

## Personal Safety

---

1. Stay alert, watch what you are doing and use common sense when operating a power tool. Do not use a power tool while you are tired or under the influence of drugs, alcohol or medication. A moment of inattention while operating power tools may result in serious personal injury.
2. Use personal protective equipment. Always wear eye protection. Protective equipment such as dust mask, non-skid safety shoes, hard hat, or hearing protection used for appropriate conditions will reduce personal injuries.
3. Prevent unintentional starting. Ensure the switch is in the off-position before connecting to power source and/or battery pack, picking up or carrying the tool.
4. Remove any adjusting key or wrench before turning the power tool on. A wrench or a key left attached to a rotating part of the power tool may result in personal injury.
5. Do not overreach. Keep proper footing and balance at all times. This enables better control of the power tool in unexpected situations
6. Dress properly. Do not wear loose clothing or jewellery. Keep your hair, clothing and gloves away from moving parts. Loose clothes, jewellery or long hair can be caught in moving parts.
7. If devices are provided for the connection of dust extraction and collection facilities, ensure these are connected and properly used. Use of dust collection can reduce dust-related hazards.
8. Do not let familiarity gained from frequent use of tools allow you to become complacent and ignore tool safety principles. A careless action can cause severe injury within a fraction of a second.

## Power Tool Use And Care

---

1. Do not force the power tool. Use the correct power tool for your application. The correct power tool will do the job better and safer at the rate for which it was designed.
2. Do not use the power tool if the switch could not turn it on and off. Any power tool that cannot be controlled with the switch is dangerous and must be repaired.
3. Disconnect the plug from the power source and/or the battery pack from the power tool before making any adjustments, changing accessories, or storing power tools. Such preventive safety measures reduce the risk of starting the power tool accidentally.
4. Store idle power tools out of the reach of children and do not allow persons unfamiliar with the power tool or these instructions to operate the power tool. Power tools are dangerous in the hands of untrained users.
5. Maintain power tools. Check for misalignment or binding of moving parts, breakage of parts and any other condition that may affect the power tool's operation. If damaged, have the power tool repaired before use. Many accidents are caused by poorly maintained power tools.
6. Keep cutting tools sharp and clean. Properly maintained cutting tools with sharp cutting edges are less likely to bind and are easier to control.
7. Use the power tool, accessories and tool bits etc. in accordance with these instructions, taking into account the working conditions and the work to be performed. Use of the power tool for operations different from those intended could result in a hazardous situation.
8. Keep handles and grasping surfaces dry, clean and free from oil and grease. Slippery handles and grasping surfaces do not allow for safe handling and control of the tool in unexpected situations.

## Battery Tool Use And Care

---

1. Recharge only with the charger specified by the manufacturer. A charger that is suitable for one type of battery pack may create a risk of fire when used with another battery pack.
2. Use power tools only with specifically designated battery packs. Use of any other battery packs may create a risk of injury and fire.
3. When battery pack is not in use, keep it away from other metal objects, like paper clips, coins, keys, nails, screws or other small metal objects that can make a connection from one terminal to another. Shorting the battery terminals together may cause burns or a fire.
4. Under abusive conditions, liquid may be ejected from the battery; avoid contact. If contact occurs, flush with water. If liquid contacts eyes, additionally seek medical help. Liquid ejected from the battery may cause irritation or burns.
5. Do not use a battery pack or tool that is damaged or modified. Damaged or modified batteries may exhibit unpredictable behaviour resulting in fire, explosion or risk of injury.
6. Do not expose a battery pack or tool to fire or excessive temperature. Exposure to fire or temperature above 130 °C may cause explosion.
7. Follow all charging instructions and do not charge the battery pack or tool outside the temperature range specified in the instructions. Charging improperly or at temperatures outside the specified range may damage the battery and increase the risk of fire.

## Service

---

1. Have your power tool serviced by a qualified repair person using only identical replacement parts. This will ensure that the safety of the power tool is maintained.
2. Never service damaged battery packs. Service of battery packs should only be performed by the manufacturer or authorized service providers.
3. Follow instruction for lubricating and changing accessories.

## Cordless Blower Safety Warnings

---

1. This blower is designed for blowing in and around the garage, shop or home. This is not recommended for rough, porous or uneven surfaces. This device is not designed for industrial applications. The device cannot be used for other purposes than its intended use.
2. Wear ear protectors. Exposure to noise can cause hearing loss. Wear safety goggles or eye protection when using this power tool. For additional protection against electric shock, be sure to wear rubber gloves.
3. Do not operate the tool near people, especially children or pets. Turn it off if they get too close. Maintain a safe distance of at least 5m from other people when using the tool. Never direct the blower towards bystanders or pets. Never blow debris in the direction of bystanders or pets.
4. Only operate the tool during broad daylight or with adequate artificial light. Do not switch on the tool in enclosed or poorly ventilated spaces or in the presence of inflammable, explosive substances such as liquids, gasses and powders.
5. Do not get distracted and always concentrate on what you are doing. Use common sense. Never operate the tool when you are tired, sick or under the influence of alcohol or other drugs.
6. Keep all the air intakes and the blower tube free of dust, lint, hair and other material that may cause a reduction in air flow.
7. Prevent unintentional starting, ensure the switch is in the off-position before connecting to battery pack, picking up or carrying the appliance. Never blow dangerous materials, such as nails, fragments of glass, or blades.
8. Switch the motor off and remove the battery when the tool is not being used, left unattended, being cleaned or being moved from one place to another. When the tool is not in use, store it in a dry place and out of reach of children.

### Battery Safety

---

#### **WARNING**

This battery can only be used in the machines included in the TOLSEN X20V lithium-ion power platform system. This battery can only be used cooperatively with the designated battery charger.

Li-Ion batteries, if incorrectly used, stored or charged will cause a fire, burn and explosion hazard. Failure to follow these instructions may cause overheating or fire.

1. Keep the battery out of reach of children.
2. The battery should be charged at ambient temperatures between 5 and 40°C (ideally around 20°C) . After charging, allow 15 minutes for the battery to cool before use.
3. The Battery Charger monitors battery temperature and voltage while charging. DO NOT leave batteries on charge for extended periods and NEVER store batteries on charge. Ensure that the charger is disconnected from the mains supply after use.
4. When not in use batteries should be stored at room temperature. Do not store the tool and battery cartridge in locations where the temperature may reach or exceed 40°C (ideally around 20°C) .
5. Ensure that battery contacts cannot accidentally short in storage. Keep batteries clean; foreign objects or dirt may cause a short. Keep away from other metal objects, for example, paperclips, coins, keys, nails and screws.
6. **DO NOT** store lithium-ion battery packs in a discharged state over a long period as this can damage the lithium-ion cells. For long-term storage, store batteries in a high charge state disconnected from the power tool.
7. Batteries can become faulty over time, individual cells in the battery can fail and the battery could short. The charger will not charge faulty batteries. Use another battery, if possible, to check correct functionality of the charger and purchase a replacement battery if a faulty battery is indicated.
8. **DO NOT** open, disassemble, crush, heat or incinerate. Do not dispose of in fire or similar.

### Battery Charger Safety

---

#### **WARNING**

This charger can only be used to charge the batteries which has TOLSEN X20V symbol. If it is used to charge other kinds of batteries, there is a risk of explosion. **DO NOT** attempt to recharge non-rechargeable batteries.

1. This is class 2 power supply. It is suitable for indoor use only.
2. Before use, the input and output technical data must be checked to secure correct use.
3. Do not use the Battery Charger in the circumstances that the output polarity does not match the load polarity.
4. Do not attempt to use the charger with any batteries other than those supplied. Keep your battery charger clean; foreign objects or dirt may cause a short or block air vents. Failure to follow these instructions may cause overheating or fire
5. If the supply cord is damaged, it must be replaced by the manufacturer, its service agent or similarly qualified persons in order to avoid a hazard.

### Save These Instructions

---

#### **WARNING**

**DO NOT let comfort or familiarity with product (gained from repeated use) replace strict adherence to safety rules for the subject product. MISUSE or failure to follow the safety rules stated in this instruction manual may cause serious personal injury.**

## Before Use

### Removing a battery

Remove the Battery from the tool by pressing the lock button, then slide the Battery out of the Battery Slot.

#### WARNING:

**DO NOT** try to remove the Battery without pressing the lock button. The tool or Battery could be damaged.

### Fitting a battery

1. Fit a battery by sliding it on to the Battery Slot of the tool until it clicks and locks into position

**Note:** Make sure the Battery and tool are lined up correctly. If the Battery does not slide into the tool easily, do not force it. Instead, slide the Battery out of the tool again, check the top of Battery and the tool battery slot are clean and undamaged and that the contacts are not bent

### Setting up the battery charger

1. If there is battery fitted, remove any battery from battery charger first

2. Insert the Battery Charger mains plug into a suitable mains socket

**Note:** The Green LED on the Charger will always bright to indicate that the charger is ready to charge the battery.

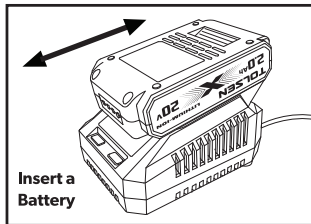
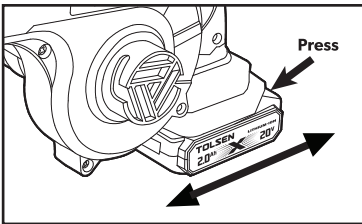

**WARNING:** Use this charger **ONLY** to charge the supplied battery or additional purchased batteries that are specifically designed for this tool.

### Charging the battery

**WARNING:** Failure to follow the correct procedure when charging batteries will result in permanent damage.

**Note:** Normal charging time is approximately 65 minutes for a recently discharged 2.0Ah capacity battery. However, if the Battery has been left in a discharged state for some time, it may take additional time to charge.















1. Slide a fully or partially discharged Battery on to the Battery Charger .

2. Once charging commences, the Red LED will on.

3. When the Battery is fully charged, the Red LED will off and Green LED will on.

**IMPORTANT:** When a low charge level is indicated, the tool may stop operating while in use, which is dangerous when operating it. Always ensure the battery pack has a good charge level.

### Note: Symbology

	Class II Double insulated for additional protection
	Read the instruction manual before using
	Wear hearing protection while operating the tool
	Wear hand protection
	Always use breathing apparatus when machining materials which generate dust.
	Wear ear protection.
	Operating environmental temperature Max 45°C
	Do not incinerate battery pack
	Do not expose to water
	Waste electrical products should not be disposed of with household waste. Please recycle where facilities exist. Check with your Local Authority or retailer for recycling advice.
	Batteries and rechargeable batteries are not household waste! As a consumer, you are required by law to dispose of all batteries and accumulators, whether or not they contain harmful substances *, at a collection point in your municipality / neighborhood or in commerce so that they can be disposed of in an environmentally sound manner.
	Battery pack is recyclable and should not be disposed of with household waste. Please recycle where facilities exist. Check with your local authority or retailer for recycling advice
	Safety alert
	For indoor use only
	Internal time lag fuse with a maximum current of 2A.

## SPECIFICATIONS

Rated Voltage	20VDC
Max. No-Load Current	13 A
Power	250 W
3-Speed control	$n_0$ : 12000 / 15000 / 18000min <sup>-1</sup>
Air Speed	50 / 64 / 94 m/s
Air Flow	1.0 / 2.4 / 3.5 m <sup>3</sup> /min
Net Weight (Tool only)	35 kg
Battery	
Battery Voltage	20VDC
Battery capacity	2.0Ah
Charger	
Input Voltage	110-120VAC 60Hz
Output Voltage	21VDC
Rated output current	2.0A
Charging Time	65 minutes fast charging(2.0Ah battery)
Protection class	<input type="checkbox"/>

### FUNCTIONS

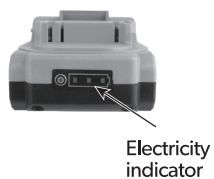
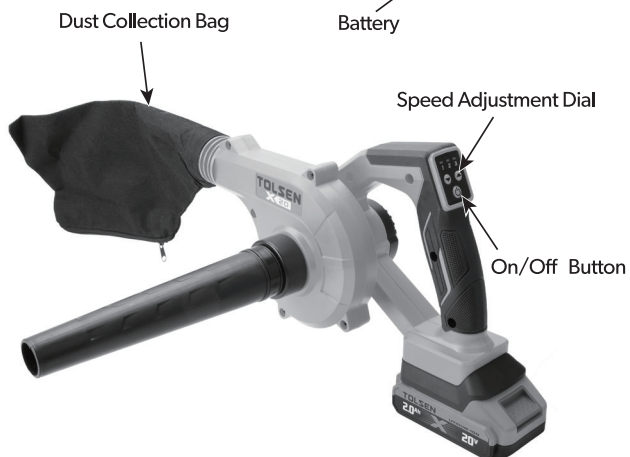
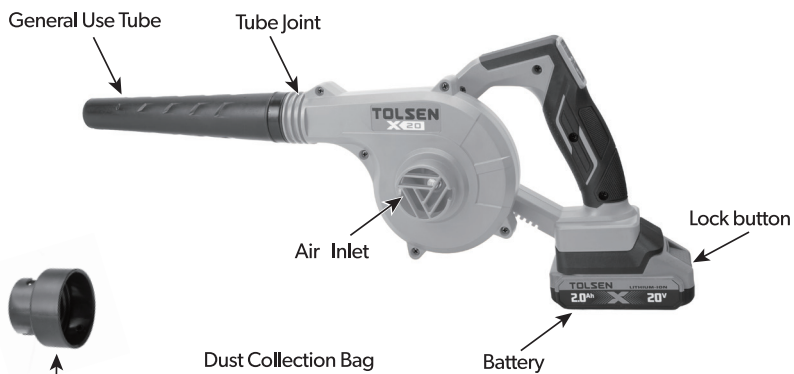

## OPERATION

### Installing and Operation for Blower Function



**CAUTION!** Ensure the battery is removed before attaching or removing the tube.  
The tube must be attached to the housing before use.

1. Line up the pegs(1) on the inside of the blow tube(3) with the notches(2) of the housing opening as shown in below picture. Turn the tube counterclockwise to fasten the tube firmly

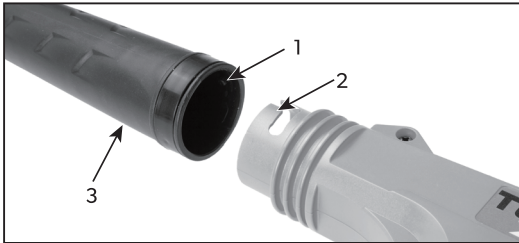

- (1) Pegs of Ring
- (2) Notch of Air Outlet
- (3) General Use Tube

2. Pull on the tube to make sure it is securely in place.  
3. To remove the tube, turn tube clockwise and pull tube out.  
4. Press the trigger switch to start blowing and control the blowing speed.



**WARNING!** Do not operate blower without tube securely in place. Never reach down into housing through tube hole.



**WARNING!** Always remove the battery when:  
1. You leave blower unattended and when storing.  
2. Checking, adjusting, cleaning, or working on blower.

### Installing Dust Collection Bag

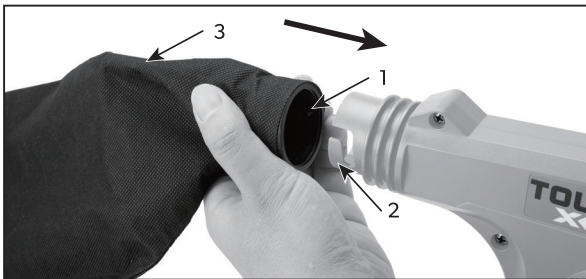

- (1) Dust Collection Bag
- (2) Pegs
- (3) Notch of Air Outlet

Line up the pegs(2) inside of the collection bag(1) with the notches(3) of the housing opening as shown in above picture. Turn bag counterclockwise to fully latch

### Installing and Operation for Vacuum Function

1. Line up the pegs(1)on the inside of the conversion connector(3)with the notches(2)of the air inlet as shown in below picture.Turn the conversion connector clockwise to fasten the conversion connector firmly.

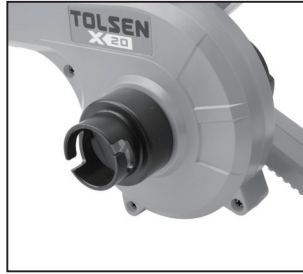
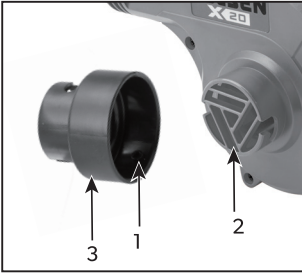

- (1)Pegs of Ring
- (2)Notch of Air Inlet
- (3)ConversionConnector

2.Line up the pegs(1)on the inside of the blow tube(3)with the notches(2)of the conversion connector as shown in below picture. Turn the blow tube counterclockwise to fasten the blow tube firmly.

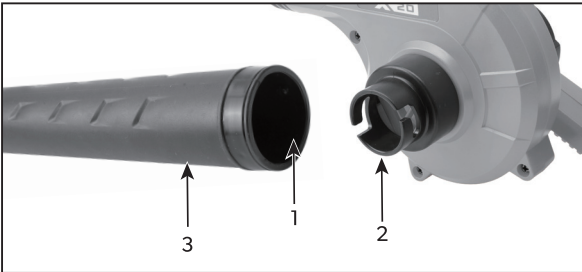

- (1)Pegs of Ring
- (2)Notch of Conversion Connector
- (3)Blow Tube

### Speed Adjustment

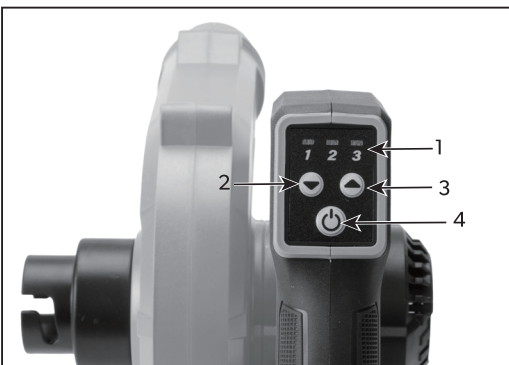

- (1)Speed Display Panel
- (2)Speed Down Button
- (3)Speed Up Button
- (4)On/Off Button

Press the on/off button(4)to start the blower and adjust the blower speed by controlling the speed up button(3)and speed down button(2).

## MAINTENANCE

 **CAUTION:** Do not let brake fluids, gasoline, petroleum-based materials touch the plastic parts. Chemicals can cause damage to the plastic, and make the plastic unserviceable.

 **CAUTION:** Do not use strong solvents or detergents on the plastic housing or components.

 **CAUTION:** Remove the battery pack from the machine before maintenance.

### CLEAN THE MACHINE

 **CAUTION:**  
The machine must be dry. Humidity can cause risks of electrical shocks.

- Clear the unwanted material out of the air vent with a vacuum cleaner.
- Do not spray the air vent or put the air vent in solvents.
- Clean the housing and the plastic components with a moist and soft cloth.

### TRANSPORTATION AND STORAGE

 **CAUTION:** Remove the battery pack from the machine before transportation and storage.

#### STORE THE MACHINE

- Clean the machine before storage.
- Make sure that the motor is not hot when you store the machine.
- Make sure that the machine does not have loose or damaged parts. If it is necessary, do these steps instructions:
  - Replace the damaged parts.
  - Tighten the bolts.
  - Speak to a person of an approved service center.
  - Store the machine in a dry area.
- Make sure that children cannot come near the machine.

## TROUBLESHOOTING

problem	possible causes	Likely Solutions
Tool will not start.	<ol style="list-style-type: none"> <li>1. Battery Pack not properly connected.</li> <li>2. Battery Pack not properly charged.</li> <li>3. Battery Pack worn out.</li> <li>4. Internal damage or wear.</li> <li>5. Contact chips of switch or battery pack deformed.</li> <li>6. Battery is not suitable for TOLSEN X20V lithium-ion power platform system</li> <li>7. Overload operation.</li> <li>8. PCB damages.</li> <li>9. Motor damages.</li> </ol>	<ol style="list-style-type: none"> <li>1. Remove Battery Pack, make sure there are no obstructions, clean battery contacts on tool, reinsert the Battery Pack according to its shape (it should only fit one way), and press firmly until the Battery Pack locks in place.</li> <li>2. Make sure Charger is connected and operating properly. Give enough time for Battery Pack to recharge properly.</li> <li>3. Dispose of old Battery Pack properly or recycle. Replace Battery Pack.</li> <li>4. Have technician service tool.</li> <li>5. Replace switch or Battery Pack</li> <li>6. Replace the battery of TOLSEN X20V</li> <li>7. Stop to use and restart the machine after cooling.</li> <li>8. Replace damaged PCB.</li> <li>9. Replace damaged motor.</li> </ol>
Tool operates slowly.	<ol style="list-style-type: none"> <li>1. Battery Pack wearing out.</li> <li>2. Low battery</li> <li>3. Blocked motor housing vents.</li> </ol>	<ol style="list-style-type: none"> <li>1. Dispose of old Battery Pack properly or recycle. Replace Battery Pack.</li> <li>2. Recharge or replace a fully charged battery</li> <li>3. Clean the Blocked motor housing vents</li> </ol>
Excessive noise or rattling.	Internal damage or wear.( gear or bearings, for example.)	Have technician service tool.



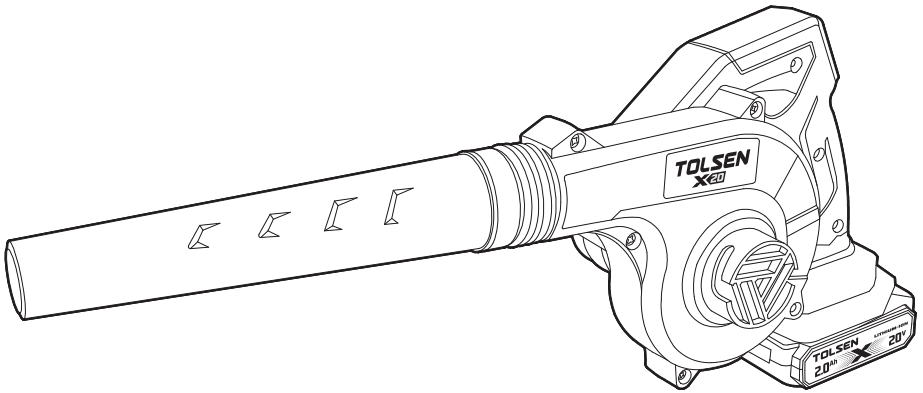

**SUZHOU TOLSEN  
TOOLS CO.,LTD.**

[www.tolseentools.com](http://www.tolseentools.com)

TOLSEN is a trademark or  
registered trademark of TOLSEN  
TOOLS. All rights reserved.  
MADE IN CHINA

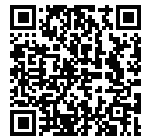

SCAN TO VISIT  
PRODUCT LINK