

# TOLSEN X<sub>20</sub>

## 96022/96422

### LI-ION CORDLESS IMPACT SCREWDRIVER

INSTRUCTION MANUAL

20V LITHIUM-ION



RoHS

**BL** BRUSHLESS  
MOTOR

INDUSTRIAL

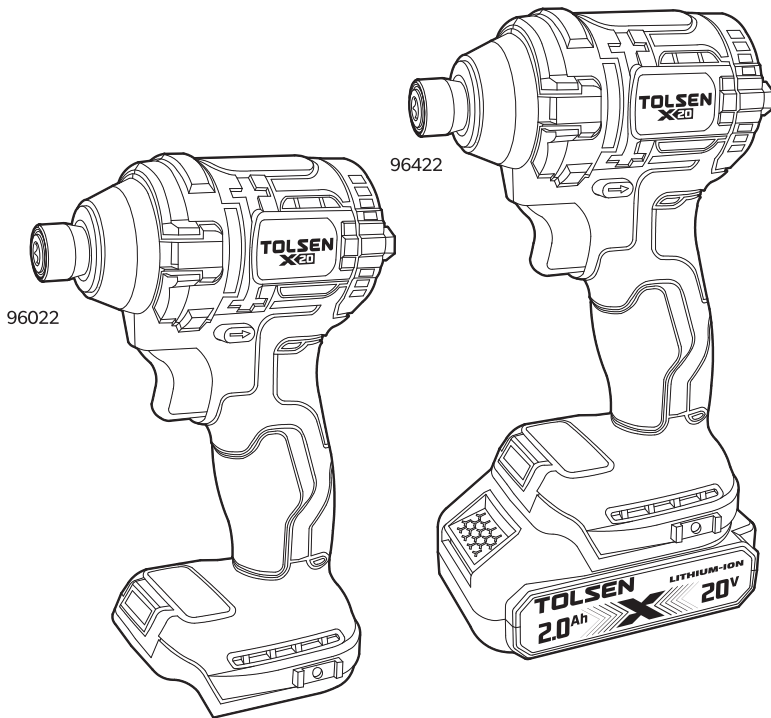

SAVE THIS MANUAL !

You will need this manual for safety instructions, operating procedures and warranty.

Put it and the original sales receipt in a safe dry place for future reference.

## IMPORTANT SAFETY INFORMATION

### General Power Tool Safety Warnings

---

**WARNING** Read all safety warnings and all instructions. Failure to follow the warnings and instructions may result in electric shock, fire and/or serious injury.

**WARNING:** This appliance is not intended for use by persons (including children) with reduced, physical or mental capabilities or lack of experience or knowledge unless they have been given supervision or instruction concerning use of the appliance by a person responsible for their safety.

Children must be supervised to ensure that they do not play with the appliance.

Save all warnings and instructions for future reference

The term "power tool" in the warnings refers to your mains-operated (corded) power tool or battery-operated (cordless) power tool.

### Work area safety

---

1. Keep work area clean and well lit. Cluttered or dark areas invite accidents.
2. Do not operate power tools in explosive atmospheres, such as in the presence of flammable liquids, gases or dust. Power tools create sparks which may ignite the dust or fumes.
3. Keep children and bystanders away while operating a power tool. Distractions can cause you to lose control.

### Electrical safety

---

1. Power tool plugs must match the outlet. Never modify the plug in any way. Do not use any adapter plugs with earthed (grounded) power tools. Unmodified plugs and matching outlets will reduce risk of electric shock.
2. Avoid body contact with earthed or grounded surfaces, such as pipes, radiators, ranges and refrigerators. There is an increased risk of electric shock if your body is earthed or grounded.
3. Do not expose power tools to rain or wet conditions. Water entering a power tool will increase the risk of electric shock.
4. Do not abuse the cord. Never use the cord for carrying, pulling or unplugging the power tool. Keep cord away from heat, oil, sharp edges or moving parts. Damaged or entangled cords increase the risk of electric shock.
5. When operating a power tool outdoors, use an extension cord suitable for outdoor use. Use of a cord suitable for outdoor use reduces the risk of electric shock.
6. If operating a power tool in a damp location is unavoidable, use a residual current device (RCD) or ground fault circuit interrupter (GFCI) protected supply. Use of an RCD or GFCI reduces the risk of electric shock.
7. Power tools can produce electromagnetic fields [EMF] that are not harmful to the user. However, users of pacemakers and other similar medical devices should contact the maker of their device and/or doctor for advice before operating this power tool.

## Personal safety

---

1. Stay alert, watch what you are doing and use common sense when operating a power tool. Do not use a power tool while you are tired or under the influence of drugs, alcohol or medication. A moment of inattention while operating power tools may result in serious personal injury.
2. Use personal protective equipment. Always wear eye protection. Protective equipment such as dust mask, non-skid safety shoes, hard hat, or hearing protection used for appropriate conditions will reduce personal injuries.
3. Prevent unintentional starting. Ensure the switch is in the off-position before connecting to power source and/or battery pack, picking up or carrying the tool.
4. Remove any adjusting key or wrench before turning the power tool on. A wrench or a key left attached to a rotating part of the power tool may result in personal injury.
5. Do not overreach. Keep proper footing and balance at all times. This enables better control of the power tool in unexpected situations
6. Dress properly. Do not wear loose clothing or jewellery. Keep your hair, clothing and gloves away from moving parts. Loose clothes, jewellery or long hair can be caught in moving parts.
7. If devices are provided for the connection of dust extraction and collection facilities, ensure these are connected and properly used. Use of dust collection can reduce dust-related hazards.
8. Do not let familiarity gained from frequent use of tools allow you to become complacent and ignore tool safety principles. A careless action can cause severe injury within a fraction of a second.

## Power tool use and care

---

1. Do not force the power tool. Use the correct power tool for your application. The correct power tool will do the job better and safer at the rate for which it was designed.
2. Do not use the power tool if the switch could not turn it on and off. Any power tool that cannot be controlled with the switch is dangerous and must be repaired.
3. Disconnect the plug from the power source and/or the battery pack from the power tool before making any adjustments, changing accessories, or storing power tools. Such preventive safety measures reduce the risk of starting the power tool accidentally.
4. Store idle power tools out of the reach of children and do not allow persons unfamiliar with the power tool or these instructions to operate the power tool. Power tools are dangerous in the hands of untrained users.
5. Maintain power tools. Check for misalignment or binding of moving parts, breakage of parts and any other condition that may affect the power tool's operation. If damaged, have the power tool repaired before use. Many accidents are caused by poorly maintained power tools.
6. Keep cutting tools sharp and clean. Properly maintained cutting tools with sharp cutting edges are less likely to bind and are easier to control.
7. Use the power tool, accessories and tool bits etc. in accordance with these instructions, taking into account the working conditions and the work to be performed. Use of the power tool for operations different from those intended could result in a hazardous situation.
8. Keep handles and grasping surfaces dry, clean and free from oil and grease. Slippery handles and grasping surfaces do not allow for safe handling and control of the tool in unexpected situations.

## Battery Tool Use and Care

---

1. Recharge only with the charger specified by the manufacturer. A charger that is suitable for one type of battery pack may create a risk of fire when used with another battery pack.
2. Use power tools only with specifically designated battery packs. Use of any other battery packs may create a risk of injury and fire.
3. When battery pack is not in use, keep it away from other metal objects, like paper clips, coins, keys, nails, screws or other small metal objects that can make a connection from one terminal to another. Shorting the battery terminals together may cause burns or a fire.
4. Under abusive conditions, liquid may be ejected from the battery; avoid contact. If contact occurs, flush with water. If liquid contacts eyes, additionally seek medical help. Liquid ejected from the battery may cause irritation or burns.
5. Do not use a battery pack or tool that is damaged or modified. Damaged or modified batteries may exhibit unpredictable behaviour resulting in fire, explosion or risk of injury.
6. Do not expose a battery pack or tool to fire or excessive temperature. Exposure to fire or temperature above 130 °C may cause explosion.
7. Follow all charging instructions and do not charge the battery pack or tool outside the temperature range specified in the instructions. Charging improperly or at temperatures outside the specified range may damage the battery and increase the risk of fire.

## Service

---

1. Have your power tool serviced by a qualified repair person using only identical replacement parts. This will ensure that the safety of the power tool is maintained.
2. Never service damaged battery packs. Service of battery packs should only be performed by the manufacturer or authorized service providers.
3. Follow instruction for lubricating and changing accessories.

## Impact Driver Safety Warnings

---

1. Hold power tools by insulated gripping surfaces when performing an operation where the cutting tool may contact hidden wiring or its own cord. Contact with a " live " wire will make exposed metal parts of the tool " live " and shock the operator.
2. Maintain labels and nameplates on the tool. These carry important safety information. If unreadable or missing, contact TOLSEN for a replacement.
3. Avoid unintentional starting. Prepare to begin work before turning on the tool.
4. Do not lay the tool down until it has come to a complete stop. Moving parts can grab the surface and pull the tool out of your control.

## Battery Safety

---



### WARNING

This battery can only be used in the machines included in the TOLSEN X20V lithium-ion power platform system.

This battery can only be used cooperatively with the designated battery charger.

Li-Ion batteries, if incorrectly used, stored or charged will cause a fire, burn and explosion hazard.

Failure to follow these instructions may cause overheating or fire.

1. Keep the battery out of reach of children.
2. The battery should be charged at ambient temperatures between 5 and 40°C (ideally around 20°C) . After charging, allow 15 minutes for the battery to cool before use.
3. The Battery Charger monitors battery temperature and voltage while charging. DO NOT leave batteries on charge for extended periods and NEVER store batteries on charge. Ensure that the charger is disconnected from the mains supply after use.
4. When not in use batteries should be stored at room temperature. Do not store the tool and battery cartridge in locations where the temperature may reach or exceed 40°C (ideally around 20°C) .
5. Ensure that battery contacts cannot accidentally short in storage. Keep batteries clean; foreign objects or dirt may cause a short. Keep away from other metal objects, for example, paperclips, coins, keys, nails and screws.
6. **DO NOT** store lithium-ion battery packs in a discharged state over a long period as this can damage the lithium-ion cells. For long-term storage, store batteries in a high charge state disconnected from the power tool.
7. Batteries can become faulty over time, individual cells in the battery can fail and the battery could short. The charger will not charge faulty batteries. Use another battery, if possible, to check correct functionality of the charger and purchase a replacement battery if a faulty battery is indicated.
8. **DO NOT** open, disassemble, crush, heat or incinerate. Do not dispose of in fire or similar.

## Battery Charger Safety

---



### WARNING

This charger can only be used to charge the batteries which has TOLSEN X20V symbol. If it is used to charge other kinds of batteries, there is a risk of explosion. **DO NOT** attempt to recharge non-rechargeable batteries.

1. This is class 2 power supply. It is suitable for indoor use only.
2. Before use, the input and output technical data must be checked to secure correct use.
3. Do not use the Battery Charger in the circumstances that the output polarity does not match the load polarity.
4. Do not attempt to use the charger with any batteries other than those supplied. Keep your battery charger clean; foreign objects or dirt may cause a short or block air vents. Failure to follow these instructions may cause overheating or fire
5. If the supply cord is damaged, it must be replaced by the manufacturer, its service agent or similarly qualified persons in order to avoid a hazard.

## Before Use

### Removing a battery

Remove the Battery from the tool by pressing the lock button, then slide the Battery out of the Battery Slot.

#### WARNING:

**DO NOT** try to remove the Battery without pressing the lock button. The tool or Battery could be damaged.

### Fitting a battery

1. Fit a battery by sliding it on to the Battery Slot of the tool until it clicks and locks into position

**Note:** Make sure the Battery and tool are lined up correctly. If the Battery does not slide into the tool easily, do not force it. Instead, slide the Battery out of the tool again, check the top of Battery and the tool battery slot are clean and undamaged and that the contacts are not bent

### Setting up the battery charger

1. If there is battery fitted, remove any battery from battery charger first

2. Insert the Battery Charger mains plug into a suitable mains socket

**Note:** The Green LED on the Charger will always bright to indicate that the charger is ready to charge the battery.

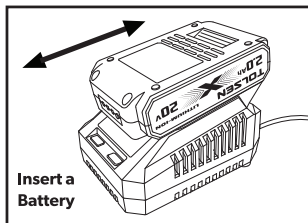
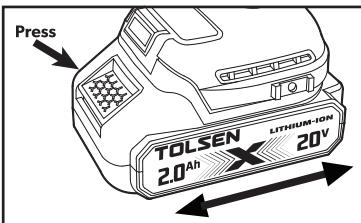

**WARNING:** Use this charger ONLY to charge the supplied battery or additional purchased batteries that are specifically designed for this tool.

















**WARNING:** Failure to follow the correct procedure when charging batteries will result in permanent damage.

**Note:** Normal charging time is approximately 1hr for a recently discharged 2.0Ah capacity battery. However, if the Battery has been left in a discharged state for some time, it may take additional time to charge.

1. Slide a fully or partially discharged Battery on to the Battery Charger .
2. Once charging commences, the Red LED will on.
3. When the Battery is fully charged, the Red LED will off and Green LED will on.

**IMPORTANT:** When a low charge level is indicated, the tool may stop operating while in use, which is dangerous when operating it. Always ensure the battery pack has a good charge level.

### Note: Symbology

	Class II Double insulated for additional protection
	CE conformity
	Read the instruction manual before using
	Wear hearing protection while operating the tool
	Wear hand protection
	Always use breathing apparatus when machining materials which generate dust.
	Wear ear protection.
	Operating environmental temperature Max 45°C
	Do not incinerate battery pack
	Do not expose to water
	Waste electrical products should not be disposed of with household waste. Please recycle where facilities exist. Check with your Local Authority or retailer for recycling advice.
	Batteries and rechargeable batteries are not household waste! As a consumer, you are required by law to dispose of all batteries and accumulators, whether or not they contain harmful substances *, at a collection point in your municipality / neighborhood or in commerce so that they can be disposed of in an environmentally sound manner.
	Battery pack is recyclable and should not be disposed of with household waste. Please recycle where facilities exist. Check with your local authority or retailer for recycling advice
	Safety alert
	For indoor use only
	Internal time lag fuse with a maximum current of 2A.

## SPECIFICATIONS

Rated Voltage	20VDC
No-load Speed	0-1440min <sup>-1</sup> /0-2180min <sup>-1</sup> /0-2900min <sup>-1</sup> /0-3660min <sup>-1</sup>
Impact frequency	0-1800 bpm/0-2700 bpm/0-3600 bpm/0-4500 bpm
Chuck type	1/4" HEX
Torque	70N·m(51ft.lbs.)/185N·m(137ft.lbs.)/260N·m(192ft.lbs.)/310N·m(229ft.lbs.)
Battery pack (96022 not include)	
Battery pack Voltage	20VDC
Battery capacity	2.0Ah
Charger (96022 not include)	
Input Voltage	220-240VAC 50/60Hz
Output Voltage	21VDC
Rated output current	2.0A
Charging Time	65 minutes charging(2.0Ah battery)
Protection class	□



### FUNCTIONS

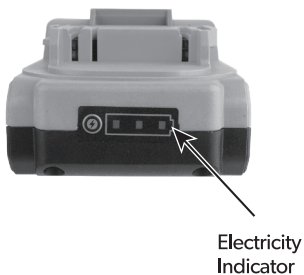

## OPERATING INSTRUCTIONS

**!** Read the **ENTIRE IMPORTANT SAFETY INFORMATION** section at the beginning of this manual including all text under subheadings therein before set up or use of this product.

### Tool Set Up

#### **!** WARNING

**TO PREVENT SERIOUS INJURY FROM ACCIDENTAL OPERATION:** Make sure that the Trigger is in the off-position and remove its Battery Pack before performing any procedure in this section.

### Battery Charging

Charge battery after unpacking and before using this tool. Follow instructions included with battery charger.

### Attaching/Removing Accessories

#### CAUTION!

Only use 1/4" hex shank bits designed for impact use. Verify bit fits the Chuck precisely before use.

1. Pull Collar forward and insert an appropriate impact-rated accessory into the hex drive Chuck. Pull on bit to ensure it is secure.
2. To remove, pull Collar forward, remove bit from Chuck and then release Collar.

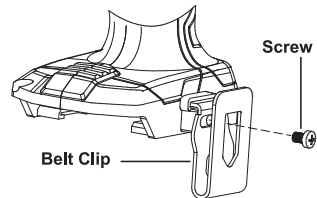
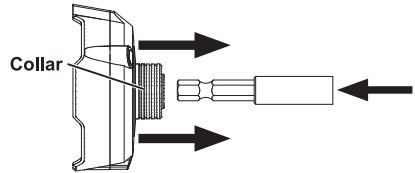

### Attaching Belt Clip

Using supplied screw to attach belt clip. Clip can be attached to either side.

### Workpiece and Work Area Set Up

1. Designate a work area that is clean and well lit. The work area must not allow access by children or pets to prevent distraction and injury.
2. Secure loose workpieces using a vise or clamps (not included) to prevent movement while working.
3. There must not be objects, such as utility lines, nearby that will present a hazard while working.

### General Operating Instructions

1. Make sure that the Trigger Switch is in the off-position, then attach the Battery Pack.
2. Insert an appropriate impact-rated accessory into the driver.
3. Set Direction Switch.

**Forward:** Push Switch in on right side (arrow pointing forward) for clockwise rotation.

**Reverse:** Push Switch in on left side (arrow pointing backward) for counter-clockwise rotation.

**Trigger Lock:** Push Switch to the center to lock the Trigger.

#### CAUTION!

Set Direction Switch to center Trigger Lock position during set up, when changing bits or when tool is idle.

4. Install bit and select direction of rotation.

**NOTICE:** Do not change direction of rotation while Chuck is rotating. Wait until Chuck has come to a complete stop before changing direction.

5. Press Trigger Switch to start the tool. The Work Lights will turn on when Trigger Switch is pressed and turn off a few seconds after Trigger Switch is released.

6. The tool has variable speed.

To increase speed, apply more pressure to Trigger Switch.

To decrease speed, lessen pressure on Trigger Switch.

7. Tighten or loosen the fastener(s) as required.

**Note:** The amount of actual torque will vary depending on the cleanness and condition of the threads and other factors. If tightening critical components, chase threads before assembling components and check the actual torque applied to the fastener with a mechanical torque wrench (not supplied).

8. When finished using the Impact Driver, release Trigger and center Direction Switch to lock Trigger.

9. To prevent accidents, turn off the tool and remove its Battery Pack after use. Clean, then store the tool indoors out of children's reach

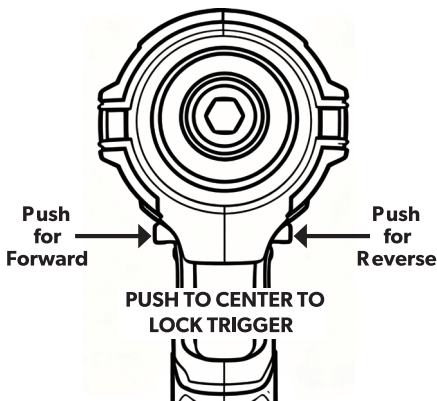

## MAINTENANCE

**WARNING: ALWAYS** disconnect from the mains power supply, before carrying out any maintenance/ cleaning of the charger. Remove the battery before carrying out any maintenance/ cleaning of the tool.

**Note:** Both the tool and the charger contain no user-serviceable parts. If the device does not perform as outlined in this manual, return it to an authorised service centre for repair

### General inspection

- Regularly check that all the fixing screws are tight
- Inspect the supply cord of the tool, prior to each use, for damage or wear. Repairs should be carried out by an authorised service centre. This advice also applies to extension cords used with this tool.

### Cleaning

- Keep your tool clean at all times. Dirt and dust will cause internal parts to wear quickly, and shorten the machine's service life. Clean the body of your machine with a soft brush, or dry cloth. If available, use clean, dry, compressed air to blow through the ventilation holes
- Clean the tool casing with a soft damp cloth using a mild detergent. Do not use alcohol, petrol or strong cleaning agents
- Never use caustic agents to clean plastic parts

### Lubrication

- Slightly lubricate all moving parts at regular intervals with a suitable spray lubricant



### Disposal

Always adhere to national regulations when disposing of power tools that are no longer functional and are not viable for repair.

**Li-Ion**

- Do not dispose of power tools, or other waste electrical and electronic equipment (WEEE), with household waste.
- Contact your local waste disposal authority for information on the correct way to dispose of power tools

### TROUBLESHOOTING

problem	possible causes	Likely Solutions
Tool will not start.	<ol style="list-style-type: none"> <li>1. Battery Pack not properly connected.</li> <li>2. Battery Pack not properly charged.</li> <li>3. Battery Pack worn out.</li> <li>4. Internal damage or wear. (Carbon brushes or Trigger, for example.)</li> <li>5. Contact chips of switch or battery pack deformed.</li> <li>6. Battery is not suitable for TOLSEN X20V lithium-ion power platform system</li> <li>7. Overload operation</li> </ol>	<ol style="list-style-type: none"> <li>1. Remove Battery Pack, make sure there are no obstructions, clean battery contacts on tool, reinsert the Battery Pack according to its shape (it should only fit one way), and press firmly until the Battery Pack locks in place.</li> <li>2. Make sure Charger is connected and operating properly. Give enough time for Battery Pack to recharge properly.</li> <li>3. Dispose of old Battery Pack properly or recycle. Replace Battery Pack.</li> <li>4. Have technician service tool.</li> <li>5. Replace switch or Battery Pack</li> <li>6. Replace the battery of TOLSEN X20V</li> <li>7. Stop to use and restart the machine after cooling.</li> </ol>
Tool operates slowly.	<ol style="list-style-type: none"> <li>1. Excess pressure applied to workpiece.</li> <li>2. Battery Pack wearing out.</li> <li>3. Low battery</li> </ol>	<ol style="list-style-type: none"> <li>1. Decrease pressure, allow tool to do the work.</li> <li>2. Dispose of old Battery Pack properly or recycle. Replace Battery Pack.</li> <li>3. Recharge or replace a fully charged battery</li> </ol>
Performance decreases over time.	<ol style="list-style-type: none"> <li>1. Chuck damaged.</li> <li>2. Battery Pack worn out.</li> <li>3. Output shaft and center shaft worn out.</li> </ol>	<ol style="list-style-type: none"> <li>1. Have qualified technician replace chuck.</li> <li>2. Dispose of old Battery Pack properly or recycle. Replace Battery Pack.</li> <li>3. Have technician service tool.</li> </ol>
Excessive noise or rattling.	Internal damage or wear.( gear or bearings, for example.)	Have technician service tool.
Overheating.	<ol style="list-style-type: none"> <li>1. Forcing tool to work too fast.</li> <li>2. Blocked motor housing vents.</li> </ol>	<ol style="list-style-type: none"> <li>1. Allow tool to work at its own rate.</li> <li>2. Clean the Blocked motor housing vents</li> </ol>

# CE DECLARATION OF CONFORMITY

WE

SUZHOU TOLSEN TOOLS CO.,LTD.  
198 HUASHAN ROAD, ZHANGJIAGANG,  
JIANGSU, CHINA

Declare that the product  
96022/96422  
HION CORDLESS IMPACT SCREWDRIVER

Complies with the essential health and safety requirements of the following Directices:  
council directive 2006/42/EC

Standards and technical specifications referred to:

EN 62841-1:2015  
EN 62841-2-1:2018+A11:2019  
EN 55014-1:2017  
EN 55014-2:2015  
EN 60335-2-29:2004+A2:2010+A11:2018 to  
be used in conjunction with EN 60335-1:2012  
+A11:2014+A13:2017+A1:2019+A2:2019+A14:2019 and  
EN 62233:2008 the Low Voltage Directive 2014/35/EU

Authorised Signatory and technical file holder

Signed for and on behalf of:

SUZHOU TOLSEN TOOLS CO.,LTD.  
198 HUASHAN ROAD, ZHANGJIAGANG,  
JIANGSU, CHINA

WANG QING

Group Quality Director

on:07/02/2025





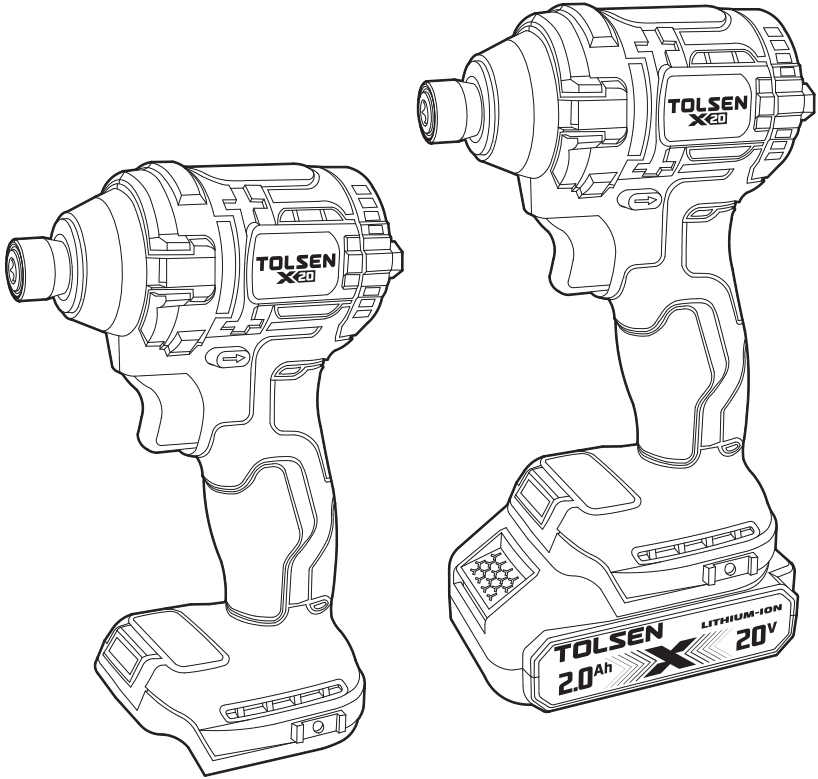

**SUZHOU TOLSEN  
TOOLS CO.,LTD.**

[www.tolseentools.com](http://www.tolseentools.com)

TOLSEN is a trademark or  
registered trademark of TOLSEN  
TOOLS. All rights reserved.  
MADE IN CHINA



SCAN TO VISIT  
PRODUCT LINK  
96022



SCAN TO VISIT  
PRODUCT LINK  
96422